

Article number: 204040M1637A1X

Description: E+G levelling foot
GN 40-40-M16-37-A1-X

Note: X With female thread, External hexagon

Measures

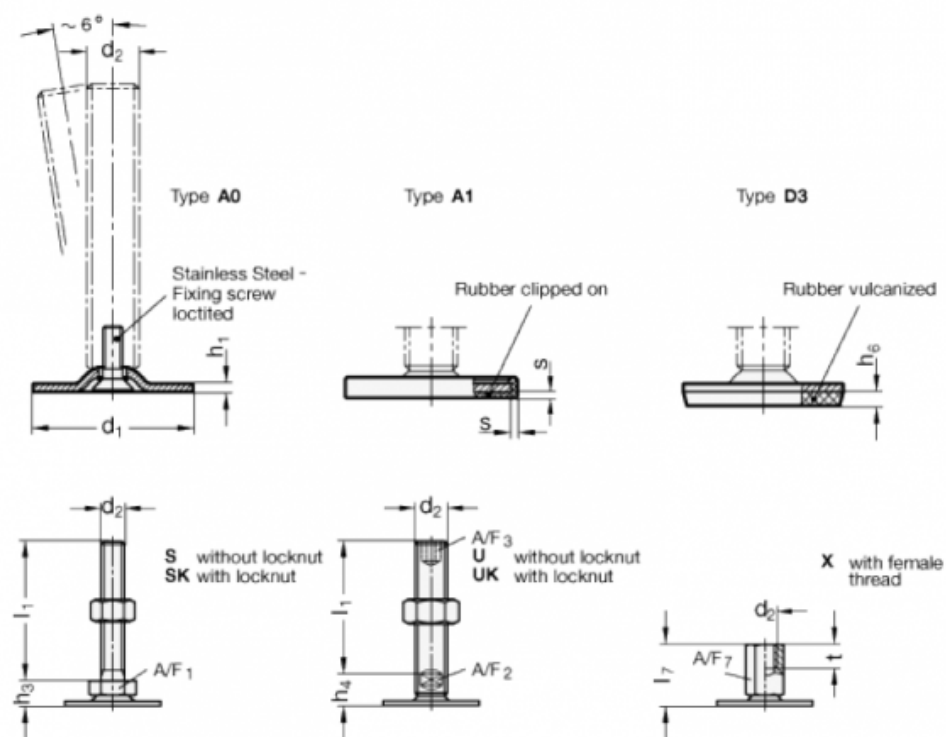

A/F7	= 22
d1	= 40
d2	= M16
h1	= 2
h6	=
l7	= 37
s	= 1.5
t	= 16